

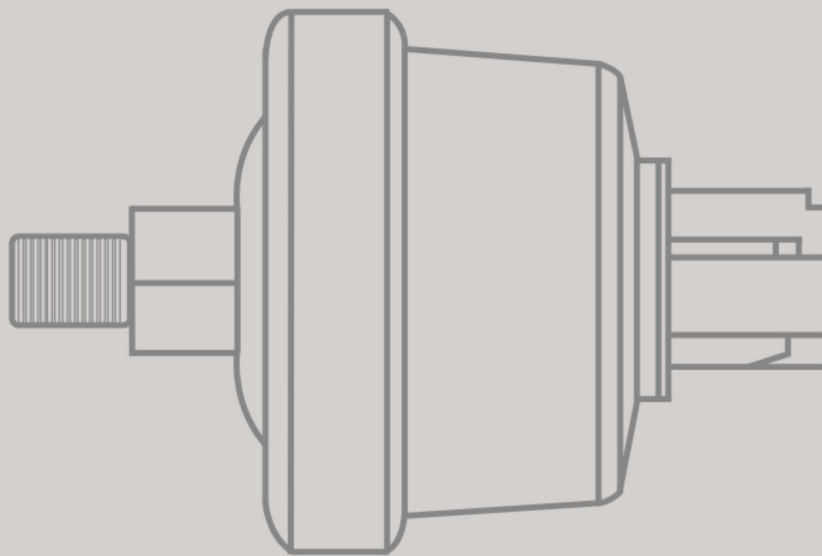

PIEZAS ELÉCTRICAS PARA AUTOMÓVILES

ROCA DE OCCIDENTE C.A. DISTRIBUIDOR OFICIAL DE LA MARCA GEN JAPAN



GEN TRADING CO.,LTD. JAPAN



23100-11080G

Aplicación Toyota

GEN JAPON

BOMBA DE GASOLINA MECANICA TOYOTA STARLET 2E TP775 GFUP-T33 GEN UND



23100-15000G

Aplicación Toyota

GEN JAPON

BOMBA DE GASOLINA MECANICA TOYOTA COROLLA 4AF AE92/AE101 TP738 GFUP-T30 GEN UND (Recien Llegado)



23100-19195G

Aplicación Toyota

GEN JAPON

BOMBA DE GASOLINA MECANICA TOYOTA COROLLA AE82 4AC TP682 GFUP-T23 GEN UND (Recien Llegado)



23100-35040G

Aplicación Toyota

GEN JAPON

BOMBA DE GASOLINA MECANICA TOYOTA HILUX 22R TP765 GFUP-T32 GEN UND (Recien Llegado)



23100-61011G

Aplicación Toyota

GEN JAPON

BOMBA DE GASOLINA MECANICA TOYOTA 1F 2F FJ40 M/VIEJO TP501 GFUP-T36 GEN UND (Recien Llegado)



23100-61050G

Aplicación Toyota

GEN JAPON

BOMBA DE GASOLINA MECANICA TOYOTA 2F BURBUJA MACHITO 3 TUBOS FJ40 TP605, GFUP-T14 GEN UND (Recien Llegado)



23100-61060G

Aplicación Toyota

GEN JAPON

BOMBA DE GASOLINA MECANICA TOYOTA 2F FJ40 FJ45 TP-695 GFUP-T24 GEN UND (Recien Llegado)



23100-61100G

Aplicación Toyota

GEN JAPON

BOMBA DE GASOLINA MECANICA TOYOTA SAMURAY 3F FJ70 FJ75 TP-742 GFUP-T31 GEN UND (Recien Llegado)



23100-69085G

Aplicación Toyota

GEN JAPON

BOMBA DE GASOLINA MECANICA TOYOTA 4.5 1FZ -24 VAL GFUP-T35 UND GEN UND (Recien Llegado)



83320-0K060G

Aplicación Toyota

GEN JAPON

FLOTADOR DE BOMBA DE GASOLINA TOYOTA 4RUNNER FOURTUNER KAVAK 1GR-FE/4.0 GF-X253 GEN UND (Recien Llegado)



83320-13170G

Aplicación Toyota

GEN JAPON

FLOTADOR DE BOMBA DE GASOLINA TOYOTA COROLLA NEW SENSATION 2003-08 GF-X323 GEN UND (Recien Llegado)

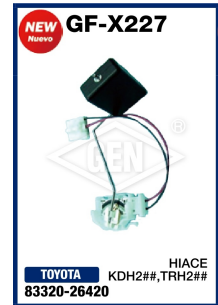

83320-26420G

Aplicación Toyota

GEN JAPON

FLOTADOR DE BOMBA DE GASOLINA TOYOTA HIACE 2005-14 GF-X227 GEN UND (Recien Llegado)



83320-35640G

Aplicación Toyota

GEN JAPON

FLOTADOR DE BOMBA DE GASOLINA TOYOTA FJ CRUISER 4.0 2007-10 GF-X262 (Recien Llegado)



83320-52260G

Aplicación Toyota

GEN JAPON

FLOTADOR DE BOMBA DE GASOLINA TOYOTA YARIS SPORT BLETA 2006-10 GF-X219 GEN UND (Recien Llegado)



83320-60420G

Aplicación Toyota

GEN JAPON

FLOTANTE DE BOMBA DE GASOLINA TOYOTA MACHITO 4.5 CHASIS LARGO GF-X181 GEN UND (Recien Llegado)



83320-60440G

Aplicación Toyota

GEN JAPON

FLOTADOR DE BOMBA DE GASOLINA TOYOTA 4RUNNER 2003-08 FLOTANTE GF-X209 GEN UND (Recien Llegado)



83320-69035G

Aplicación Toyota

GEN JAPON

FLOTADOR DE BOMBA DE GASOLINA TOYOTA MACHITO 4.5 3F FJ70 GF-TY20 GEN UND (Recien Llegado)



83320-69145G

Aplicación Toyota

GEN JAPON

FLOTANTE DE BOMBA DE GASOLINA TOYOTA HEMBRITA 4.5 FZJ75 CARBURADA GF-X324 GEN UND (Recien Llegado)



83320-69306G

Aplicación Toyota

GEN JAPON

FLOTADOR DE BOMBA DE GASOLINA
TOYOTA MERU PRADO 4RUNNER
GF-X183 GEN UND (Recien Llegado)



83320-69555G

Aplicación Toyota

GEN JAPON

FLOTADOR DE BOMBA DE GASOLINA
TOYOTA MACHITO 4.5 2010-23 GF-X254
GEN UND (Recien Llegado)



83320-80118G

Aplicación Toyota

GEN JAPON

FLOTADOR DE BOMBA DE GASOLINA
TOYOTA HILUX 22R 4X2 2.4 GF-TY29 GEN
UND (Recien Llegado)



83320-80317G

Aplicación Toyota

GEN JAPON

FLOTADOR DE BOMBA DE
GASOLINA TOYOTA DYNA 14B
GF-X224 GEN UND (Recien Llegado)



83320-80400G

Aplicación Toyota

GEN JAPON

FLOTADOR DE BOMBA TOYOTA
HILUX 3RZ 2RZ 2000-05 GF-X214
GEN UND (Recien Llegado)



GF-X251

Aplicación Toyota

GEN JAPON

FLOTADOR DE BOMBA DE GASOLINA
TOYOTA FORTUNER HILUX KAVAK 4.0
83320-0K020 GEN UND (Recien Llegado)



84450-60070J

Aplicación Toyota

GEN JAPON

RAMAL IGNICION TOYOTA 2F
FJ40 45 CBS-12 CONMUTADOR
GEN UND (Recien Llegado)



84450-60080J

Aplicación Multimarca

GEN JAPON

RAMAL IGNICION TOYOTA 2F 3F
SAMURAI CBS-34 CONMUTADOR
GEN UND (Recien Llegado)



84450-60120G

Aplicación Toyota

GEN JAPON

RAMAL IGNICION TOYOTA MACHITO
BURBUJA 4.5 CBS-56 CONMUTADOR
GEN JAPON (Recien Llegado)



84450-60140G

Aplicación Toyota

GEN JAPON

RAMAL IGNICION TOYOTA MACHITO 4.5
FZJ-80 CBS-57 1985-89 CONMUTADOR
GEN UND (Recien Llegado)



27700-15011-J

Aplicación Toyota

GEN JAPON

REGULADOR DE VOLTAJE TOYOTA 2F 3F
AVILA AVR-566 GVR-T13 ALTERNADOR
GEN UND (Recien Llegado)



TGS-125

Aplicación Ford

GEN JAPON

SENSOR DE PRESIÓN DE ACEITE MAZDA 6
2002-13 MAZDA 3 2003-14 FORD EXPLORER
FIESTA KA ECOSPORT FUSION FOCUS ROSCA
M14X1.5 (Recien Llegado)



TG-CS01

Aplicación Multimarca

GEN JAPON

SENSOR DE TEMPERATURA DE AGUA
JEEP DODGE CHRYSLER ASTRA CORSA
33004281 UND GEN JAPON



TG-5051G

Aplicación Mitsubishi

GEN JAPON

SENSOR DE TEMPERATURA DE AGUA
MITSUBISHI PAJERO ANTER L300 DIESEL
649/FE84/85/FK615 9465021200 MDO05051
UND GEN

TGO-1005



ISUZU	
94027248	
5-83151005-0	
8-94120240-0	
8-94175808-0	
8-94325724-0	
8-97011779-0	
8-97019560-0	
8-97419560-0	
8K	
PT1/8	
MD133273	

TGO-1005

Aplicación **Multimarca**

GEN JAPON

SENSOR PRESION ACEITE ISUZU
CARIBE 2300/2600 UND GEN
JAPON

TGS-58



NISSAN	
25240-89915	
25240-89920	
25240-89960	
25240-70J00	
25240-8996E	
25240-G2400	
25240-10G00	
27	
1/8-28	
0.15	

TGS-58

Aplicación **Multimarca**

GEN JAPON

SENSOR PRESION ACEITE
NISSAN TERRANO 25240-89920
GEN JAPON UND

TTS-710



87°C	
M18x1.5	

TTS-710

Aplicación **Chevrolet**

GEN JAPON

SWITCH ELECTROVENTILADOR
CHEVROLET CORSA SUZUKI SWIFT
VITARA BALENA UND GEN JAPON

TTS-FD01



100°C	
M22x1.5	

TTS-FD01

Aplicación **Ford**

GEN JAPON

SWITCH ELECTROVENTILADOR FORD
FIESTA POWER BALITA 1998-00
TTS-FD01 1652990 UND GEN JAPON

TTS-HY07



85°C	
M16x1.5	

TTS-HY07

Aplicación **Hyundai**

GEN JAPON

SWITCH ELECTROVENTILADOR
HYUNDAI ACCENT UND GEN
JAPON

TTS-M07



85°C	
M16x1.5	

MB660663
MB660664

TTS-M07

Aplicación **Mitsubishi**

GEN JAPON

SWITCH ELECTROVENTILADOR MITSUBISHI
LANCER 1973-03 GALANT 1987-93 85°C ROSCA
M16x1.5 MB660663 UND GEN JAPON

TTS-M01



85°C	
M16x1.5	

TTS-M01

Aplicación **Mitsubishi**

GEN JAPON

SWITCH ELECTROVENTILADOR MITSUBISHI
LANCER 1973-83 GALANT 1987-93 6G72/ECLIPSE
2.0 UND GEN JAPON

TTS-N25



TTS-N25

Aplicación **Nissan**

GEN JAPON

SWITCH ELECTROVENTILADOR
NISSAN ALMERA / PRIMERA/
TIIDA UND GEN JAPON

TTS-N12



90°C	
M16x1.5	

TTS-N12

Aplicación **Nissan**

GEN JAPON

SWITCH ELECTROVENTILADOR
NISSAN SENTRA B-13/14 FUEL
INYECCION UND GEN JAPON

TTS-N04

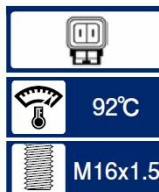

TTS-N04

Aplicación Nissan

GEN JAPON

SWITCH ELECTROVENTILADOR
NISSAN SENTRA B13
CARBURADO UND GEN JAPON

TTS-203

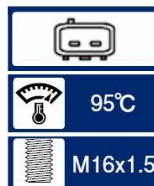

TTS-203

Aplicación Toyota

GEN JAPON

SENSOR ELECTROVENTILADOR TOYOTA
CAMRY 2.2 1991-01 RAV4 89428-33010
GEN UND (Recien Llegado)

TTS-N18

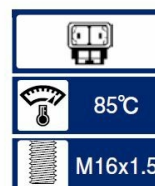

TTS-N18

Aplicación Nissan

GEN JAPON

SWITCH ELECTVENTILADOR
NISSAN SENTRA CARBURADO
UND GEN JAPON

TTS-319

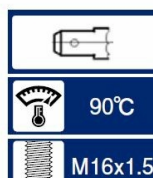

TTS-319

Aplicación Mazda

GEN JAPON

SWITCH ELETROVENTILADOR
MAZDA 323 1985-96 626 90°C
UND GEN JAPON

GB-HY4



GB-HY4

Aplicación Hyundai

GEN JAPON

SWITCH INTERRUPTOR LUZ DE RETROCESO
HYUNDAI H1 1997-07 H100 KIA PICANTO
93860-4A000 UND GEN JAPON

GB-HY6



GB-HY6

Aplicación Multimarca

GEN JAPON

SWITCH RETROCESO HYUNDAI
ATOS GETZ KIA PICANTO RIO
93860-02002 UND GEN JAPON

GB-277



GB-277

Aplicación Multimarca

GEN JAPON

SWITCH RETROCESO MITSUBISHI
L300 PANEL P04/P14 2.0 LT 95-99
MD730710 UND GEN JAPON

GB-T03



GB-T03

Aplicación Multimarca

GEN JAPON

SWITCH RETROCESO TOYOTA
FORTUNER KAVAK 2.7 GG50
84210-0K010 GEN UND (Recien Llegado)

GS-HY03



GS-HY03

Aplicación Multimarca

GEN JAPON

SWITCH STOP 93810-3K000
SONATA/SANTA FE/SPORTAGE
UND GEN JAPON



GS-NS02

Aplicación Multimarca

GEN JAPON

SWITCH STOP INTERRUPTOR LUZ DE FRENO
25320-AX00A NISSAN TIIDA 2007-12 X-TRAIL
2007-12 RENAULT CLIO 2019 UND GEN JAPON

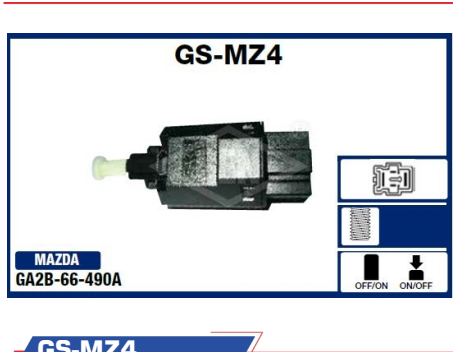

GS-MZ4

Aplicación Mazda

GEN JAPON

SWITCH STOP INTERRUPTOR LUZ DE
FRENO GA2B-66-490A MAZDA 626
1992-97 323 1994-98 UND GEN JAPON



GS-NS03

Aplicación Renault

GEN JAPON

SWITCH STOP INTERRUPTOR LUZ DE FRENO
RENAULT KOLEOS 2008> NISSAN TIIDA 2007-12
X-TRAIL TODAS ALMERA 2000-06 25320-4M400



GS-M1

Aplicación Multimarca

GEN JAPON

SWITCH STOP MB435457
CB1A/2A LANCER UND GEN
JAPON



GS-M2B

Aplicación Mitsubishi

GEN JAPON

SWITCH STOP MISTUBISHI
PANEL L300 MB113078 L200/300
CARBURTAD UND GEN JAPON



GS-M6

Aplicación Mitsubishi

GEN JAPON

SWITCH STOP MITSUBISHI
CANTER 444 MB249318 UND GEN
JAPON



GS-M4

Aplicación Mitsubishi

GEN JAPON

SWITCH STOP MITSUBISHI FUSO
MC134474 UND GEN JAPON

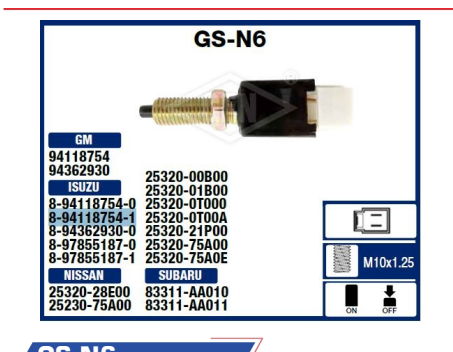

GS-N6

Aplicación Multimarca

GEN JAPON

SWITCH STOP NISSAN SENTRA
B14 CARBURADO 25320-75A0E
UND GEN JAPON

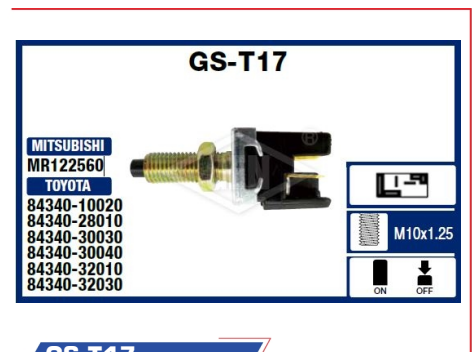

GS-T17

Aplicación Multimarca

GEN JAPON

SWITCH STOP TOYOTA GB-T17
AE82 UND GEN JAPON



GS-T18

Aplicación Toyota

GEN JAPON

SWITCH STOP TOYOTA STARLET
84340-10020 UND GEN JAPON

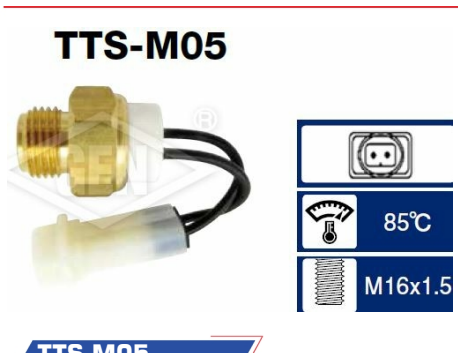

TTS-M05

Aplicación Mitsubishi

GEN JAPON

SWITH ELECTROVENTILADOR
MITSUBISHI LANCER CARBURADO
85°C MB605079 UND GEN JAPON



TG-CS04

Aplicación Multimarca

GEN JAPON

VALVULA DE TEMPERATURA DE AGUA
CENTURY LUMINA 3 PINES 1009681
ROSCA 3/8NPT UND GEN JAPON



TG-EA005

Aplicación Chevrolet

GEN JAPON

VALVULA DE TEMPERATURA DE AGUA
CHEVROLET CORSA HASTA 2000 ASTRA
HONDA CIVIC 1997-01 ACCORD 1999-02 ROSCA
M12X1.5 9041079



TG-DW02

Aplicación Chevrolet

GEN JAPON

VALVULA DE TEMPERATURA DE AGUA
CHEVROLET MONTANA CORSA IMPALA
CENTURY ESPERO ROSCA 3/8-19 UND GEN
JAPON



TG-DW04

Aplicación Chevrolet

GEN JAPON

VALVULA DE TEMPERATURA DE AGUA
CHEVROLET OPTRA CORSA CIELO
ROSCA 3/8-19 3439088 UND GEN JAPON



TG-EA041

Aplicación Chevrolet

GEN JAPON

VALVULA DE TEMPERATURA DE AGUA FIAT
PALIO MOD VIEJO JEEP CHEROKEE KK 2.8 2008
KJ 2002-08 ROSCA M UND GEN JAPON



TG-FD09

Aplicación Ford

GEN JAPON

VALVULA DE TEMPERATURA DE AGUA
FORD EXPEDITION ESCAPE 5226356
F1AF-12A648B UND GEN JAPON



TG-KA07

Aplicación Ford

GEN JAPON

VALVULA DE TEMPERATURA DE AGUA KIA
SPORTAGE 1994-03 NISSAN TERRANO 1990-07
FORD MAVERICK 1993-98 OK01118840 UND GEN

TG-KA08

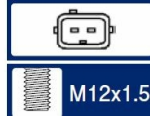

TG-KA08

Aplicación Multimarca

GEN JAPON

VALVULA DE TEMPERATURA DE AGUA KIA SPORTAGE 1995-97 K857418840 UND GEN JAPON

TG-EA033



TG-EA033

Aplicación Renault

GEN JAPON

VALVULA DE TEMPERATURA DE AGUA RENAULT TWINGO 1.2 1993-07 MEGANE 1996-03 ROSCA M12X1.5 9109810 7700737571 UND GEN

TG-89907

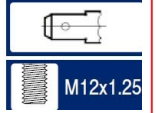

TG-89907

Aplicación Multimarca

GEN JAPON

VALVULA DE TEMPERATURA NISSAN PATROL 2.8 1997-00 3.0 2007 PATHFINDER 1999-04 25080-89907 UND GEN JAPON

TG-HY03

Aplicación Hyundai

GEN JAPON

VALVULA TEMP. HYUNDAI SONATA 2.0/3.0 98- UND GEN JAPON

TG-SU01

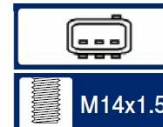

TG-SU01

Aplicación Multimarca

GEN JAPON

VALVULA TEMPERATURA CHEVROLET GRAND VITARA 13650-50G01 GEN JAPON UND

TG-6910



TG-6910

Aplicación Chevrolet

GEN JAPON

VALVULA TEMPERATURA CHEVROLET LUV DMAX 3.5 LT 94235691 UND GEN JAPON

TG-MZ11



TG-MZ11

Aplicación Multimarca

GEN JAPON

VALVULA TEMPERATURA MAZDA 3 2.0 LT L35G-18-840 UND GEN JAPON

TG-M1380

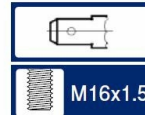

TG-M1380

Aplicación Multimarca

GEN JAPON

VALVULA TEMPERATURA MITSUBISHI MONTERO 3.0 LT MA603427 UND GEN JAPON

TG-20011

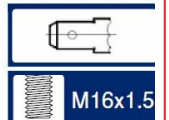

TG-20011

Aplicación Toyota

GEN JAPON

VALVULA TEMPERATURA TOYOTA 2F FJ40/45 83420-20011 UND GEN JAPON

GB-621



DAIHATSU
84210-60021
GM
94840339
TOYOTA
84210-60021
84210-01010
84210-62021

27mm
18x1.5

OFF ON

GB-621

Aplicación Toyota

GEN JAPON

SWITCH RETROCESO TOYOTA SAMURAI FJ60 70 AE82 AE92 DYNA 84210-60021 BU88 GEN JAPON UND (Recien Llegado)

GB-623



TOYOTA
84210-14030
84210-14040
84210-60030

27mm
18x1.5

OFF ON

GB-623

Aplicación Toyota

GEN JAPON

SWITCH RETROCESO TOYOTA 4.5/4500 BURBUJA BU211 84210-60030 GEN JAPON UND (Recien Llegado)

GB-899/907



TOYOTA
84210-12040
84210-52050
84210-04010

27mm
18x1.5

OFF ON

GB-899

Aplicación Toyota

GEN JAPON

SWITCH RETROCESO TOYOTA COROLLA BABY CAMRY AE111 HILUX 2.7 MERU YARIS 1.3 GB-899/907 84210-12040 GEN UND (Recien Llegado)

GB-910



DAIHATSU
84210-87514

22mm
14x1.5

OFF ON

GB-910

Aplicación Multimarca

GEN JAPON

SWITCH RETROCESO TOYOTA TERIOS K3VE 84210-87415 GEN JAPON UND (Recien Llegado)

GB-GM02



ALFA ROMEO
71740080
DAEWOO
90245033
FIAT
71740022
71740080
73503780

GM
96192077
90482454
94770529
90245033
9185908
1239196
1239266

PEUGEOT
2257.56
SAAB
4232666
9185908

19mm
12x1.5

OFF ON

GB-GM02

Aplicación Chevrolet

GEN JAPON

SWITCH RETROCESO CHEVROLET AVEO OPTRA CORSA LANOS NUBIRA TACUMA 96192077 GEN UND (Recien Llegado)

GPV-1



GPV-1

Aplicación Toyota

GEN JAPON

VALVULA PCV TOYOTA COROLLA AE101 ARAYA SKY BABY PANTALLA 12204-28010 4.5 GEN UND (Recien Llegado)

GPV-12



GPV-12

Aplicación Chevrolet

GEN JAPON

VALVULA PCV CHEVROLET SUPER CARRY GEN UND (Recien Llegado)

GPV-15



GPV-15

Aplicación Honda

GEN JAPON

VALVULA PCV HONDA CIVIC METALICO 1987-91 CON ROSCA GEN UND (Recien Llegado)

GPV-18



GPV-18

Aplicación Toyota

GEN JAPON

VALVULA PCV TOYOTA CAMRY 2.4 PREVIA YARIS 12204-28020 GEN UND (Recien Llegado)

GPV-19



GPV-19

Aplicación Toyota

GEN JAPON

VALVULA PCV TOYOTA CAMRY
2.2 CELICA SXV10 12204-74020
GEN UND (Recien Llegado)

GPV-20



GPV-20

Aplicación Toyota

GEN JAPON

VALVULA PCV TOYOTA CAMRY
2.2 SXV20 RAV 4 12204-74030
GEN UND (Recien Llegado)

GPV-21



GPV-21

Aplicación Toyota

GEN JAPON

VALVULA PCV TOYOTA YARIS COROLLA 2003-14
4RUNNER KAVAK FORTUNER ZZE142 121 122
12204-75020 GEN UND (Recien Llegado)

GPV-23



GPV-23

Aplicación Toyota

GEN JAPON

VALVULA PCV TOYOTA PRADO 4RUNNER
CAMRY 6 CIL 12204-46030/10 GEN UND
(Recien Llegado)

GPV-25



GPV-25

Aplicación Toyota

GEN JAPON

VALVULA PCV TOYOTA CAMRY
3.5/2GRFE/GSV40 COROLLA 2003-08
12204-31040 GEN UND (Recien Llegado)

GPV-4



GPV-4

Aplicación Toyota

GEN JAPON

VALVULA PCV CHEVROLET GRAN VITARA
WAGON R ESTEEN TOYOTA
AE82/CIVIC/TERIOS COROLLA 12204-97401
15030/50 GEN UND (Recien Llegado)

GPV-6



GPV-6

Aplicación Toyota

GEN JAPON

VALVULA PCV TOYOTA STARLET
COROLLA 1.8 2F 12204-10020/30
GEN UND (Recien Llegado)

GPV-8



GPV-8

Aplicación Toyota

GEN JAPON

VALVULA PCV TOYOTA PRADO
MERU 12204-65010 GEN UND
(Recien Llegado)

GPV-9



GPV-9

Aplicación Toyota

GEN JAPON

VALVULA PCV TOYOTA 4RUNNER
FORTUNER KAVAK 12204-31020
GEN UND (Recien Llegado)

GS-H4



HONDA
35350-SE0-003
35350-SE0-013
35350-SE0-A01
35350-SE0-A02
ISUZU
8-94109863-0
HYUNDAI
93810-29100
93810-32000
93810-32001
MITSUBISHI
MB487644
MB596608

M10x1.25

ON/OFF ON/OFF

GS-H4
Aplicación Hyundai

GEN JAPON

SWITCH STOP INTERRUPTUR LUZ DE FRENO KIA PICANTO SPORTAGE MITSUBISHI MONTERO 3.5 HONDA ACCORD HYUNDAI GETZ 93810-320GEN (Recien Llegado)

GS-OP02



OPEL
1240589
90059581
90059582

M12x1.5

ON OFF

GS-OP02
Aplicación Chevrolet

GEN JAPON

SWITCH STOP INTERRUPTOR LUZ DE FRENO CHEVROLET MONZA CORSA 90059582 GEN UND (Recien Llegado)

GS-SU04



CITROEN
453454
FIAT
71742588
PEUGEOT
453454
TOYOTA
84340-09020
84340-09040
84340-19025
84340-49045
84340-69015
84340-69025
GM
93194931
SUZUKI
37740-75H10
37740-76G20
37740-80G10
OPEL
4710280

M10x1.25

ON/OFF ON/OFF

GS-SU04
Aplicación Toyota

GEN JAPON

SWITCH STOP INTERRUPTUR LUZ DE FRENO TOYOTA YARIS 2006-09 COROLLA ZZE142 CAMRY 2GR PRADO 3.0 84340-09040 GEN UND (Recien Llegado)

GS-T12N



TOYOTA
84340-04010
84340-04020
84340-06020
84340-32050
84340-32090
84340-32110
84340-35020
84340-42010
84340-50020

M10x1.25

ON OFF

GS-T12N
Aplicación Toyota

GEN JAPON

SWITCH STOP INTERRUPTUR LUZ DE FRENO TOYOTA COROLLA BABY AE101 PRADO MERU 4340-32050 84340-04010 GEN UND (Recien Llegado)

GS-T15



TOYOTA
84340-20020
84340-20040
84340-22010
84340-22020
84340-22040
84340-30020
84340-30021
84340-30022
84340-30023

M10x1.25

ON OFF

GS-T15
Aplicación Toyota

GEN JAPON

SWITCH STOP INTERRUPTUR LUZ DE FRENO TOYOTA FJ40 45 75-85 84340-30023 GEN UND (Recien Llegado)

GS-T2



HYUNDAI
93810-21000
93810-21001
93810-21100
93810-21101
93810-24000
93810-25000
93810-29000
93820-73012
93840-31000
TOYOTA
25312-90000
84340-12020
84340-12021
84340-20010
84340-20011
84340-22040
84340-22060
84340-22070
84340-35010
84340-36030
84340-36060
84340-22071

M10x1.25

ON OFF

GS-T2
Aplicación Toyota

GEN JAPON

SWITCH STOP INTERRUPTUR LUZ DE FRENO TOYOTA UNIVERSAL 93810-21000 84340-12020 GEN UND (Recien Llegado)

GS-T5N



TOYOTA
84340-01010
84340-28010
84340-30030
84340-32010
84340-32030

M10x1.25

ON OFF

GS-T5N
Aplicación Toyota

GEN JAPON

SWITCH STOP INTERRUPTUR LUZ DE FRENO TOYOTA COROLLA AE82 84340-32010 84340-30030 GEN UND (Recien Llegado)

GS-TY06



TOYOTA
84340-02010

M10x1.25

ON OFF

GS-TY06
Aplicación Toyota

GEN JAPON

SWITCH STOP INTERRUPTUR LUZ DE FRENO 84340-02010 TOYOTA COROLLA ZZE121/122 2003-08 GEN UND (Recien Llegado)

TG-16010



M16x1.5

TG-16010
Aplicación Toyota

GEN JAPON

VALVULA TEMPERATURA TOYOTA 2F/3F COROLLA 4AC 83420-16010 GEN UND (Recien Llegado)

TG-1602

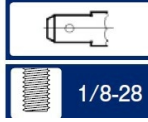

TG-1602

Aplicación Toyota

GEN JAPON

VALVULA TEMPERATURA TOYOTA
COROLLA 4AF/STARLET 2E 83420-16020
GEN UND (Recien Llegado)

TG-20040

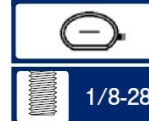

TG-20040

Aplicación Toyota

GEN JAPON

VALVULA TEMPERATURA TOYOTA
CAMRY SXV10/20 83420-20040 GEN
UND (Recien Llegado)

TG-50A0

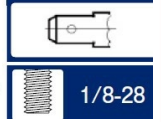

TG-50A0

Aplicación Multimarca

GEN JAPON

VALVULA TEMPERATURA
CHEVROLET SWIFT 3395475 3601364
GEN UND (Recien Llegado)

TG-DW01

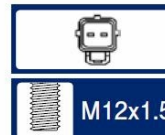

TG-DW01

Aplicación Chevrolet

GEN JAPON

VALVULA TEMPERATURA DE AGUA CHEVROLET
AVEO CORSA CIELO RACER SPARK MATIZ
NUBIRA 96181508 ROSCA M12X1.5 UND GEN
(Recien Llegado)

TG-FD11

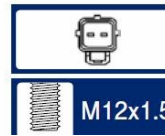

TG-FD11

Aplicación Ford

GEN JAPON

VALVULA DE TEMPERATURA DE AGUA FORD
FOCUS 2.2 RANGER MAZDA 3 MAZDA 6 626
1047284 3929104 UND GEN (Recien Llegado)

TG-H08



TG-H08

Aplicación Honda

GEN JAPON

VALVULA DE TEMPERATURA DE
AGUA HONDA ACCORD PRELUDE
ACURA GEN UND (Recien Llegado)

TG-KA03



TG-KA03

Aplicación Mitsubischi

GEN JAPON

VALVULA DE TEMPERATURA DE AGUA
MITSUBISHI MONTERO 1998-00 LANCER 1995-13
L300 1994-00 3922035510 UND GEN (Recien
Llegado)

TG-MZ05

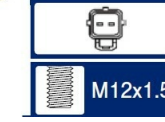

TG-MZ05

Aplicación Ford

GEN JAPON

VALVULA DE TEMPERATURA DE AGUA FORD
FOCUS 2.0 RANGER 2.5 2011 MAZDA 626 6 3
LF01-18-840 UND GEN (Recien Llegado)

TG-MZ06

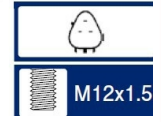

TG-MZ06

Aplicación Toyota

GEN JAPON

VALVULA DE TEMPERATURA DE AGUA TOYOTA
TERIOS K3 MAZDA 626 323 TOYOTA COROLLA
1997-02 STARLET 1996-99 YARIS 1999-05 K1K1-
(Recien Llegado)

TG-P1004

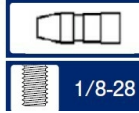

TG-P1004

Aplicación **Multimarca**

GEN JAPON

VALVULA TEMPERATURA HONDA ACCORD CIVIC 37750-PC1-004 GEN JAPON UND (Recien Llegado)

TGS-107



HYUNDAI
94750-11000 94750-21020
94750-11010 94750-21030
94750-11102 94750-31000
94750-11110 94750-35010
94750-21000 94750-35020
94750-21010 94750-35030



TGS-107

Aplicación **Multimarca**

GEN JAPON

SENSOR PRESION DE ACEITE KIA SPORTAGE RIO HYUNDAI ACCENT TUCSON TOY/MZ TGS-107 GEN JAPON UND (Recien Llegado)

TGS-112



ISUZU
8-97176230-0



TGS-112

Aplicación **Chevrolet**

GEN JAPON

SENSOR PRESION DE ACEITE ISUZU NPR 4HG1 4HF1 8-97176230-0 GEN UND (Recien Llegado)

TGS-116



ISUZU
8-98613014-0
NISSAN
25240-G150E



TGS-116

Aplicación **Chevrolet**

GEN JAPON

SENSOR PRESION DE ACEITE ISUZU 1.5 1.6 DMAX 3.5 GEN UND (Recien Llegado)

TGS-117



NISSAN
25240-4M400



TGS-117

Aplicación **Multimarca**

GEN JAPON

SENSOR PRESION DE ACEITE SENTRA B-15 TGS-117 GEN UND (Recien Llegado)

TGS-121



NISSAN
25240-4M40E



TGS-121

Aplicación **Nissan**

GEN JAPON

SENSOR PRESION DE ACEITE TGS-121 PATHFINDER R50/51/TIIDA/SENTRA B-16/C11/D22/T30 XTRAIL GEN UND (Recien Llegado)

TGS-132



GM
95961350



TGS-132

Aplicación **Chevrolet**

GEN JAPON

SENSOR DE PRESION DE ACEITE CHEVROLET AVEO OPTRA SPARK TACUMA CAPTIVA GEN UND (Recien Llegado)

TGS-46



TGS-46

Aplicación **Toyota**

GEN JAPON

SENSOR PRESION DE ACEITE TOYOTA COROLLA 90-98 TERIOS 02-14 STARLET CHEVROLET DMAX 3.5 83530-60030 GEN UND (Recien Llegado)

TGS-46S



DAIHATSU
83530-87103
83530-87201
83530-87205
83530-87703
83530-97401

MAZDA
E5D3-18-501
JF01-18-501A

DAIHATSU
SUZUKI
83530-97202
83530-B0010



TGS-46S

Aplicación **Toyota**

GEN JAPON

SENSOR DE PRESION DE ACEITE TOYOTA TERIOS TOYOTA COROLLA AE90 1987-92 83530-87201 83530-36010 GEN JAPON UND (Recien Llegado)

TTS-H01



TTS-H01

Aplicación **Honda**

GEN JAPON

SENSOR ELECTROVENTILADOR HONDA CIVIC
1987-05 ACORD 1993-12 377760-P00-003 93°C
ODYSSEY UND GEN (Recien Llegado)

TTS-N07

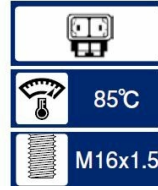

TTS-T07

Aplicación **Toyota**

GEN JAPON

SWITCH ELECTROVENTILADOR
TOYOTA COROLLA 1.6 1999-02
GEN JAPON (Recien Llegado)